

SUPER LED F7 VW



DATASHEET

DeSisti

SUPER LED F7 VW

LED Fresnel Spotlight 160W Vari-White - CRI>95

White light, with Tunable Correlated Color Temperature from 2.800 to 6.600°K

OVERVIEW

The Super LED F7 Vari-White maintains the high efficiency DE SISTI Internationally Patented optical system for LED FRESNEL while the innovative white phosphors LED ARRAY provides the ability to tune the Correlated Color Temperature from a minimum of 2.800°K to a maximum of 6.600°K with an enhanced CRI (Color Rendering Index) higher than 95 at any CCT within the range.

The Lighting Fixture is DMX Controlled for:

- 0 to 100% with a super smooth Dimming
- STEP MODE for CCT Control: Increments of 400°K every 10% of DMX variation
- CONTINUOUS MODE for CCT control.

The fixture combines the classical SPOT/FLOOD beam control on an equivalent FOCUS RANGE to a conventional lamp fresnel, with an excellent barn door cutting.

It utilizes Standard accessories from the DE SISTI range of equivalent Fresnel Lens size, such as Barndoor, Color Frame, Cones, Scrims.

MODEL	DESCRIPTION
F7VW.MO	Super LED F7 VW - Tunable CCT, Manual Operated
F7VW.PO	Super LED F7 VW - Tunable CCT, Pole Operated



WHAT'S INSIDE

FIXTURE HEAD

175 mm. (7") diameter Fresnel lens
POWERCON IN & OUT PANEL CONNECTORS.
XLR 5 Pin DMX IN & OUT PANEL CONNECTORS.
160W high output CRI>95 LED with Tunable
CCT from 2.800°K till 6.600 °K
Built In Universal Power Supply 90-250V
50/60Hz DMX controlled.

YOKES

Manual Operated Versions

Mod. LT310.110.40 M.O. stirrup with 28,57 mm
(B.S. 1 1/8") with top end for "C" clamp

Pole Operated Versions

Mod. 311.110.40 P.O. yoke with 28,57 mm.
spigot (B.S. 1 1/8"), with top end for "C" clamp

ACCESSORIES

Mod. 316.100 four leaf rotating barndoor
Mod. 317.100 color frame

CABLES

Mod. 5403.135 3 mt. (9.8 ft) detachable Blue
POWERCON power cable with bare ends.

DMX cable is not included, to be ordered
separately

DeSisti

SUPER LED F7 VW

FEATURES

Power to LED	160W - flicker free
Rated Voltage & PFC	90-250V 50-60Hz PFC 0,96
Power consumption	180W @ 230V 150W @120V
Power Connection	powerCON IN & OUT
DMX Data link USITT DMX512-A	5-pin XLR for DMX in & out. Use shielded data cables. Do not overload the daisy chain. Up to a maximum of 32 devices can be used on a single DMX chain.
DMX Channels	3: Dimmer/Light Intensity, CCT Control, Mode of CCT Control (steps or continuous)
LED ARRAY Lifetime	60.000 hours with 70% Lumen Maintenance. The LED ARRAYS are tested and certified up to LM80
CCT	Tunable from 2.800°K to 6.600°K
CRI / TLCI	CRI>95 TLCI:96
Protection Type	IP20
Max. Housing Surface Temperature	70° C
Weight of Fixture	M.O. 7,8 Kg (17.2 lb) P.O. 9,1 Kg (20.1 lb)
Weight of Barndoor	4 leaf 0,63 Kg (1.39 lb) 8 leaf 0,85 Kg (1.87 lb)
Weight of color frame	0,13 Kg (0.29 lb)
Barndoor ring diameter	Seat: 192mm / 7 3/4" - Accessory: 190mm / 7 1/2"
Scrims & color frame diameter	Seat 187mm / 7 1/3" - Accessory: 185mm / 7 1/4"
Lens diameter	175mm / 7"

DIMENSION

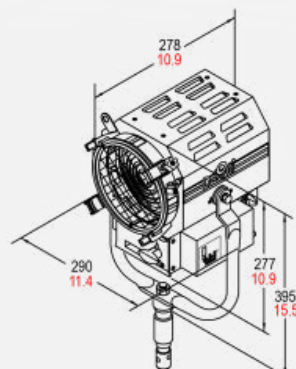

M.O.

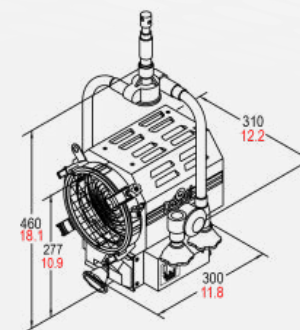

P.O.

FEATURES

175 mm. (7") diameter high quality, shock resistant Borosilicate glass Fresnel lens on spring supports.

Rugged and lightweight Carbon Steel Housing with low glare black epoxy powder coating and reinforces internal double walls.

Vari-White CCT technology with a range from 2.800°K to 6.600°K

CRI Greater than 95 at any CCT within the range

High efficiency Self Stabilizing Active Cooling: automatic, thermal stabilization of the LED operating temperature is managed by an internal thermal sensor and CPU, variable speed fan and heat sink to maintain the LED Array's constant temperature at a maximum of 65°C. The hydro dynamic bearing fan operates silently with a very low RPM.

Special Patented Optics for LED Technology.

Helix Screw driven focus mechanism which guides Teflon bushings supported LED ENGINE along 2 rods. This ensures smooth operation during focusing in any tilting position of the fixture. The Teflon bushings also provide a wiping action, which cleans the steel guide rails during focus.

The unit is equipped with a hinged lens door and wire guard. One of the 4 accessory brackets has a spring loaded locking knob to safely secure external accessories.

Accessories have been designed for one hand installation.

Available with either positive lock manual yokes for comfort and ease of handling, or pole operated yokes which can be used via the lighting pole for Panning and Tilting the lights as well as manually, since the mechanical activators are equipped with clutches.

SUPER LED F7 VW

TLCI

TUNGSTEN CCT

De Sisti SUPER LED F6 VW - 120W - @2800°K : CCT = P2791 (+0.3)
TLCI-2012: 96 (P2791)

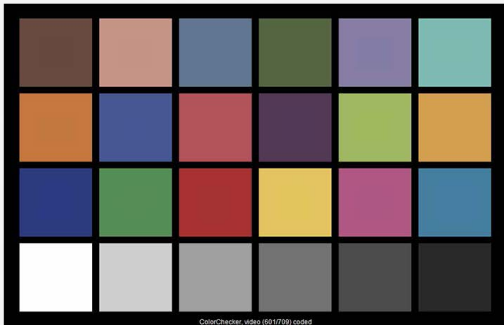

Television Lighting Consistency Index-2012

Sector	Lightness	Chroma	Hue
R	0	0	0
RY	0	0	-
Y	0	0	-
YG	0	0	0
G	0	0	0
GC	0	0	0
C	0	0	+
C/B	0	0	+
B	0	-	-
BM	0	0	+
M	0	0	+
M/R	0	0	+

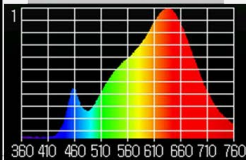

DAYLIGHT CCT

De Sisti SUPER LED F6 VW - 120W - @6600°K : CCT = D6990 (+0.4)
TLCI-2012: 96 (D6990)

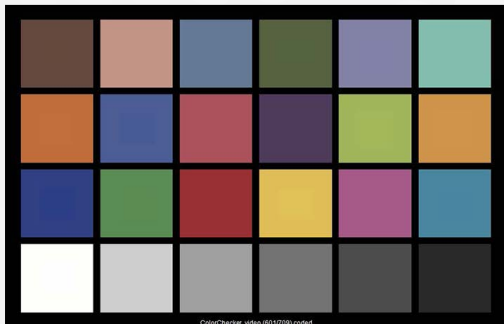

Television Lighting Consistency Index-2012

Sector	Lightness	Chroma	Hue
R	0	0	0
RY	0	0	-
Y	0	0	-
YG	0	0	0
G	0	0	0
GC	0	0	0
C	0	0	-
C/B	0	0	-
B	0	-	-
BM	0	0	0
M	0	0	0
M/R	0	0	0

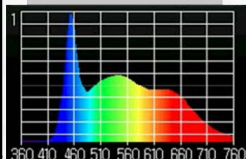

PHOTOMETRICS

// SUPER LED F7 VW

Central Light intensity (Candle Power)

Illumination center values at Distances

FULL FLOOD - C.C.T. tunable from 2.800°K to 6.600°K - 160W (CRI >95) - TLCI: 96

FLOOD @ 2.800°K CCT	12.690 cd	1.410 lux <i>131 FC</i>	508 lux <i>47 FC</i>	127 lux <i>12 FC</i>
----------------------------	-----------	----------------------------	-------------------------	-------------------------

FLOOD @ 6.600°K CCT	16.830 cd	1.870 lux <i>174 FC</i>	673 lux <i>63 FC</i>	168 lux <i>16 FC</i>
----------------------------	-----------	----------------------------	-------------------------	-------------------------

FULL SPOT - C.C.T. tunable from 2.800°K to 6.600°K - 160W (CRI >95) - TLCI: 96

SPOT @ 2.800°K CCT	64.080 cd	7.120 lux <i>661 FC</i>	2.563 lux <i>238 FC</i>	641 lux <i>60 FC</i>
---------------------------	-----------	----------------------------	----------------------------	-------------------------

SPOT @ 6.600°K CCT	84.960 cd	9.440 lux <i>877 FC</i>	3.398 lux <i>316 FC</i>	850 lux <i>79 FC</i>
---------------------------	-----------	----------------------------	----------------------------	-------------------------

3 mt *9.8 ft* 5 mt *16.4 ft* 10 mt *32.8 ft*

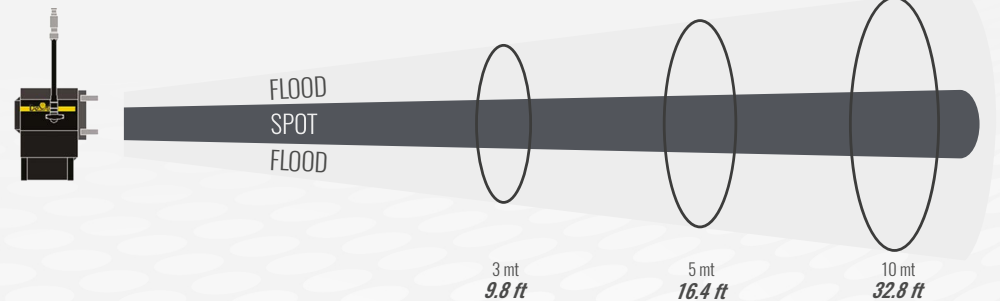

Light beam diameter with Beam Angle (50% of center value)

Beam Sizes

FLOOD	55°	3,12 mt <i>10.2 ft</i>	5,21 mt <i>17.1 ft</i>	10,41 mt <i>34.2 ft</i>
--------------	-----	---------------------------	---------------------------	----------------------------

SPOT	13°	0,68 mt <i>2.2 ft</i>	1,14 mt <i>3.7 ft</i>	2,28 mt <i>7.5 ft</i>
-------------	-----	--------------------------	--------------------------	--------------------------

Light beam diameter with Field Angle (10% of center value)

FLOOD	70°	4,20 mt <i>13.8 ft</i>	7,00 mt <i>23.0 ft</i>	14,00 mt <i>45.9 ft</i>
--------------	-----	---------------------------	---------------------------	----------------------------

SPOT	25°	1,33 mt <i>4.4 ft</i>	2,22 mt <i>7.3 ft</i>	4,43 mt <i>14.5 ft</i>
-------------	-----	--------------------------	--------------------------	---------------------------

LUX AT ANY DISTANCE = Candle Power: [Distance(in m.)]²

FC. AT ANY DISTANCE = Candle Power: [Distance(in ft)]²



SUPER LED F7 VW



OPTIONALS & ACCESSORIES

F7VW.XO.DIN	adder code to order DIN Spigot
305.310	Stainless Steel wire guard
316.100	Four leaf rotating barndoor
316.200	Eight way rotating barndoor
317.100	Color Frame
318.100	Cone with two discs (with front aperture diameter: 70 mm. 50 mm. 30 mm.)
319.100	Set of scrims - Stainless steel
319.101	Full single scrim - Stainless steel
319.102	Full double scrim - Stainless steel
319.103	1/2 single scrim - Stainless steel
319.104	1/2 double scrim - Stainless steel
91.210	Aluminum black painted "C" clamp to hang fixtures overhead and for mounting on pipe with diameters up to 52 mm. (2"), with safety pin (no adapters)
93.102	Extruded black "C" clamp with M 12 threaded stud
93.103	Extruded black "C" clamp with M 10 threaded stud
20.100	Safety cable 800 mm. long with 4 mm. diameter steel rope and safety catch.
LT310.110.40	Steel tube Manual Operated stirrup with 28,57 mm. spigot (B.S. 1 1/8"), with top end for attachment to "C" clamp.
LT310.300.40	Steel tube Manual Operated stirrup with 28,00 mm. spigot (D.I.N 1 1/9")
LT310.220.40	Steel tube Manual Operated stirrup with M 12 Threaded hole
311.110.40	Pole operated stirrup with 28,57 mm. spigot (B.S. 1 1/8"), with top end for attachment to "C" clamp.
311.300.40	Pole operated stirrup with 28,00 mm. spigot (D.I.N 1 1/9")